

Article number: 12727000030120
Description: KLEE-coil 727 000 030.120
M3 Steel, zinc-pl. & chr. yellow

Measures

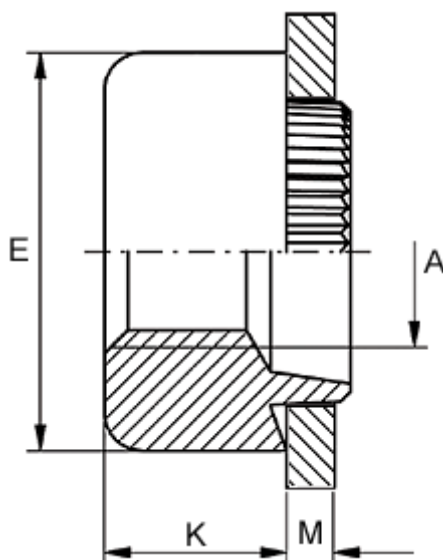

Female thread A	= M3
Height K	= 3.0
Outer diameter E	= 6.0
Plate thickness	= 1.7 to 1.9
Recommended bore diameter +0.05	= 4.0